

IGE+XAO

GROUP

Shaping the Future
of the Electrical PLM,
CAD and Simulation

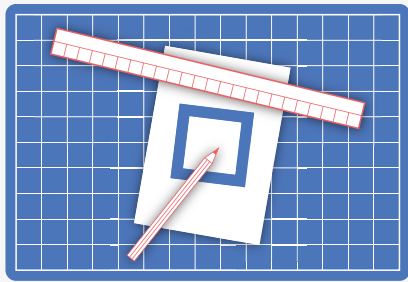



< 1980

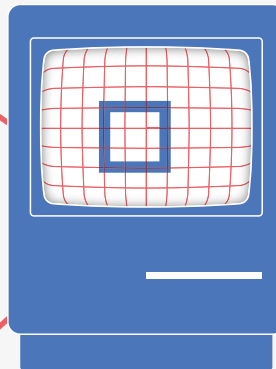

1980-1990

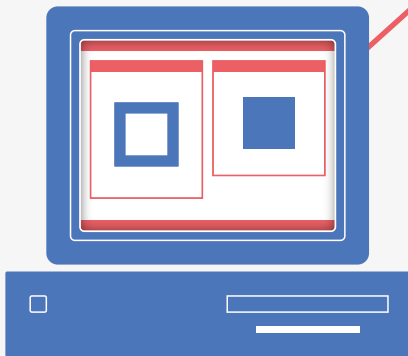

1990-2000

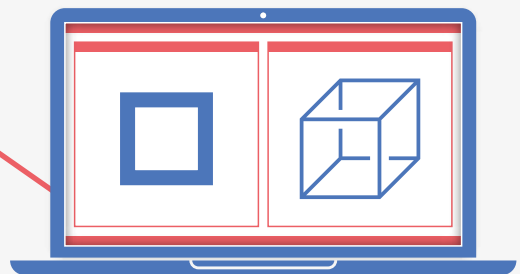

> 2000

Historically, the Group began by developing, selling and maintaining CAD (Computer Aided Design) software dedicated to the electrical industry. Electrical CAD software applications are used to design and maintain the electrical side of manufacturing processes and end products.

Today, CAD is the main business of the Group and represents 70% of its revenue. From the late 90's, the IGE+XAO Group has started the development of a software suite covering the overall requirements of the electrical harnesses design market. This new market has led the Group to start building, as early as 2005, a complete and dedicated PLM (Product Lifecycle Management) software range. These solutions have attracted numerous global players in aerospace and transportation such as Airbus, Embraer or Alstom.

Since mid-2014, with the purchase of Prosyst, IGE+XAO offers a complete software range for electrical functional simulation.



31 years of experience
Over **88,000 licences** sold
33 locations in **22 countries**
385 employees
Listed on **NYSE Euronext**
since March 1997

Subsidiaries

Belgium
Brazil
Bulgaria
Canada
China
Denmark
France
Greece
Germany
India
Italy
Morocco
Netherlands (The)
Poland
Spain
Switzerland
Tunisia
Turkey
United Kingdom
USA

R&D

Bulgaria
Denmark
France
Madagascar
Morocco
Poland
Tunisia

Support

Bulgaria
Brazil
China
France
Greece
Morocco
USA

Partners

Armenia
Austria
Australia
Azerbaijan
Belarus
Bosnia and
Herzegovina
China
Colombia
Croatia
Cyprus
Czech Republic
Hungary
Kosovo
Kyrgyzstan
Lebanon
Macedonia FYR
Moldova
Montenegro
New Zealand
Uzbekistan
Portugal
Romania
Russia
Serbia
Slovakia
Slovenia
South Korea
Tajikistan
Tunisia



A strong international presence



+ Headquarters ○ Subsidiaries X Partners ▲ Support | R&D



ABB, AgustaWestland SPA, Air France KLM, Airbus, AKKA, Akyapak, Alestis Aerospace, Alphatron, Alstom, ANURAG, ArcelorMittal, Aries Estructuras Aeroespaciales, Assytem, ATEL Netz Ag, BAM, Bauer GmbH, BBR GmbH, BE Aerospace Ltd, Beghin-Say, Beijing Zhong Xin Xing Ye Keji, Benteler, Bosal, Bouygues, Brembo SPA, CABS, Carrier, CEA, Cegelec, Cermex, Chengdu Xinzhu Road & Bridge Machinery Co. Ltd, Coca Cola, COMAU (Fiat), Composite Engineering Inc., ContiTech Vibration Control, Cote SAS, Daf-Trucks, Dalkia, Danone, DFM ZANAM-LEGMET Sp. z o.o., DHL, DRASS ENERGY SRL, Dredging International, Dunlop, Eaton, EC Engineering, ECL, EDF, Eiffage Energie, ELV SPA, Embraer, Endurance Wind Power, Enexis, Engie Ineo, Etalon-Automation LLC, Euchner GmbH, European Space Agency (ESA), Fabricom, FAdeA SA, Faiveley, Faurecia, Fokker Elmo, Footlocker, Fromagerie BEL, Fuji Seal Group, Galileo Avionica, Engie, General de Ingeniería INHISSET, General Dynamics European Land Systems- Germany, GPI, GSU/Eneco, Guérin Systèmes (Tetra Pack Group), Guinault, Hager, Haribo, Helibras, Hellenic Air Force, Henniez, Heuliez, Honda Aircraft Co., Honeywell, Houdijk Holland bv, Hydro Quebec, IMAC inc, ITER, JSC ISS-Reshetnev Company, Kestrel Aerospace, Kocher Plastik GmbH, Kraft Foods, Latelec, Latesys, Legrand, Leroy Somer, Lindt, Lotus Bakeries, LVMH, Mairie de Paris, Manitowoc Crane Group, Maral Group, MBDA, Metso Brasil Indústria e Comércio Ltda, Michelin, Microturbo (Groupe Safran), Motorflug Baden-Baden GmbH, Motorola, Mühlberg Interiors (EDAG Group), NATO, Nestlé, Neu Railways, Nexans, NMBS/SNCB, Nomos Systems, Northrop Grumman, Orano, Panasonic, Perrier, PESA Bydgoszcz SA Holding, Philips, Prinoth, Potez Aeronautique, Priva, PSA Group, Qi Qi Ha Er, RATP, Reel, Reims Aviation, Renault Group, Renault Trucks, Renson, Rio Tinto Alcan, Rolls-Royce Marine, RUAG AVIATION SA, S.A.B.C.A, Safran, Sagem, Saint Yorre, Samson AG, Saur, SCAM SPA, Schlumberger, Schneider Electric, SELEX SPA, SENER Ingeniería y Sistemas, S.A., Sepro, Shanghai Electric, Shanghai Rail Traffic, Sidel-Cermex, Siemens, Siemens Windpower, Sierra Nevada Corporation, Smurfit Kappa, SNCB, SNCF, Socata, SOGETI HT, Spie, Srbijagas, Sterela, Suez, Swedish Match Cigars NV, TEMSA, Thales, Toyota forklifts, Trakcja Polska S.A., Unilever, Valeo, Vallourec Talc de Luzenac, Van der Leun, Veolia Environnement, Vestas, Vesuvius, Vinci Energies, Volkswagen Group, VOSSLOH, Vulcanair SPA, Wabco GmbH, Wago, Wenzel Elektronik GmbH, Whirlpool Europe SRL, Xella, Wienerberger, ZF Sachs...

An important customer base

Our 41,000 customers worldwide belong to a wide range of industries including:

- Automotive
- Transportation
- Power generation
- Electrical and electronic equipment
- Food, chemical and steel industries
- Building and public works
- Engineering
- Machine building
- Automation
- Etc...

Number of licences sold

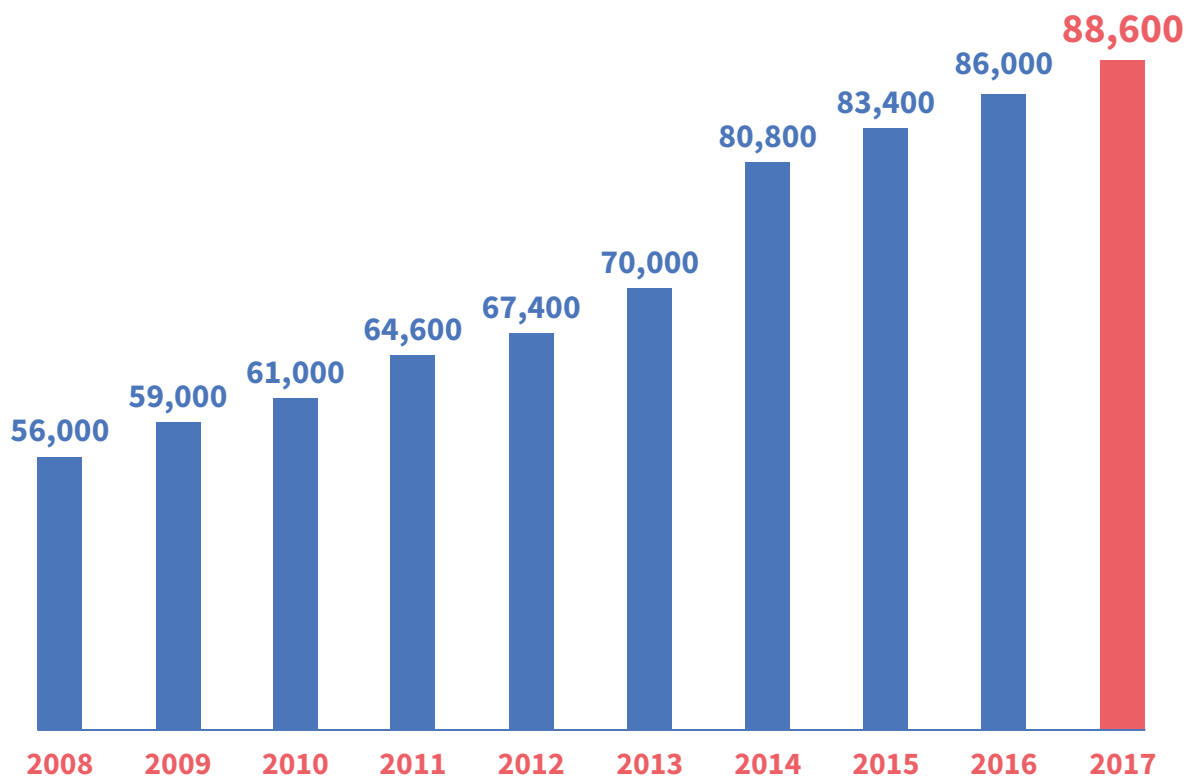



Solutions for all company sizes

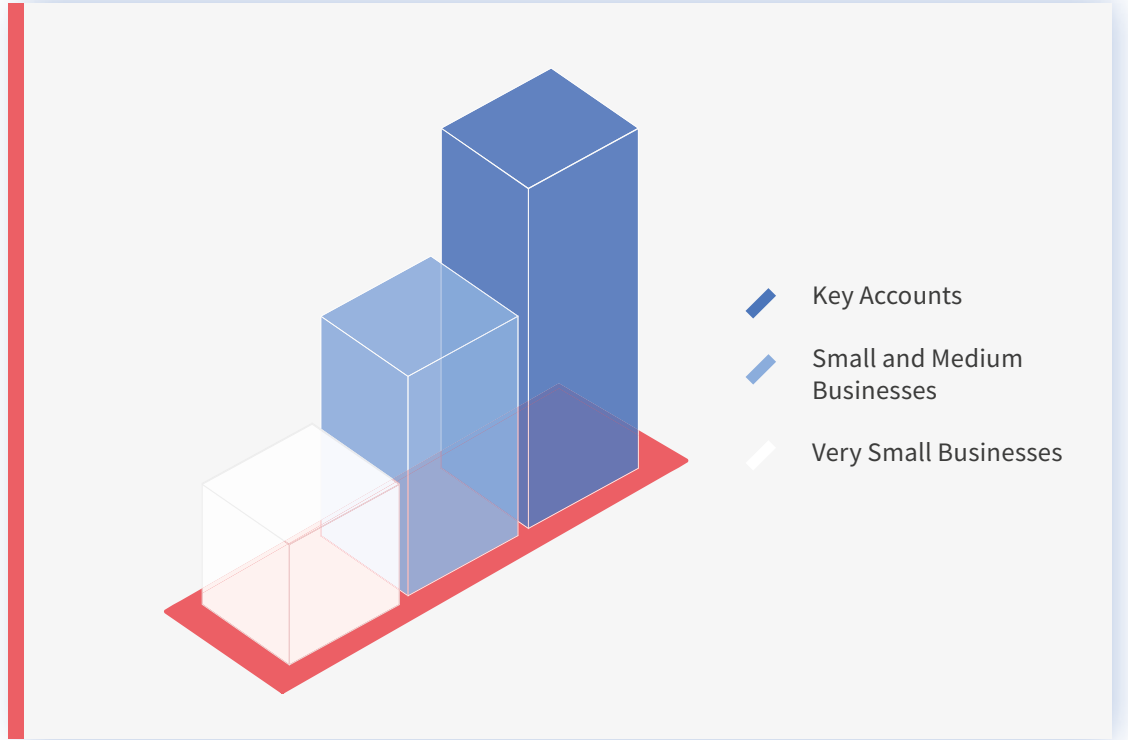

A strong presence in 8 industries

8 strategic markets

In each identified market, IGE+XAO covers the requirements with a complete range of modular products.

- **Aerospace**
- **Automotive**
- **Railway**
- **Shipbuilding**
- **Equipment & Machinery**
- **Automation & Plant**
- **Power generation & Energy**
- **Construction**

6 business domains

- **System design**
- **Electrical design (the core business of IGE+XAO)**
- **Electrical manufacturing**
- **Data management**
- **Communication**
- **Simulation and diagnostic**

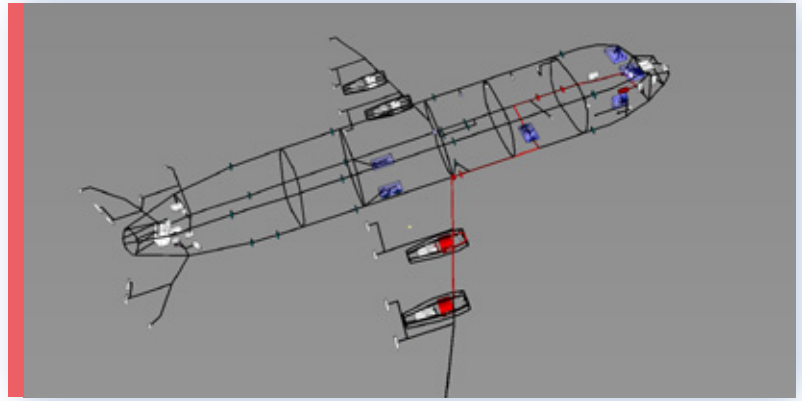

Aerospace

› Market Requirements

- More electrical aircraft
- Increasing numbers of components
- Numerous configurations to support
- More and more complex cabling
- Heterogeneous software tools
- Production time reduction

› IGE+XAO answers

- Powerful PLM (Product Lifecycle Management) suite
- Complete solution from design to manufacturing
- High level of integration
- Scalable solutions (from stand alone to PLM)
- Configuration management

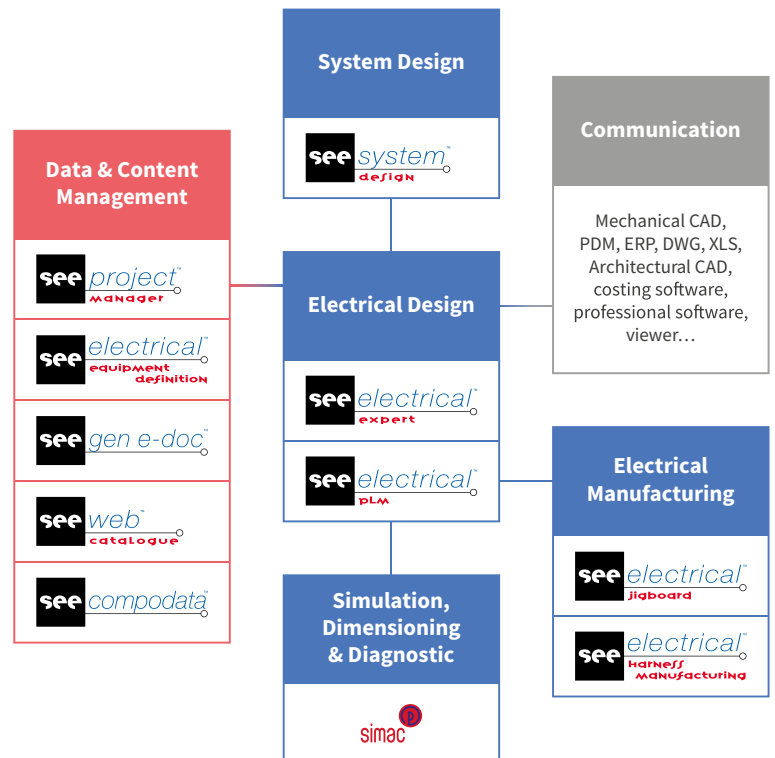

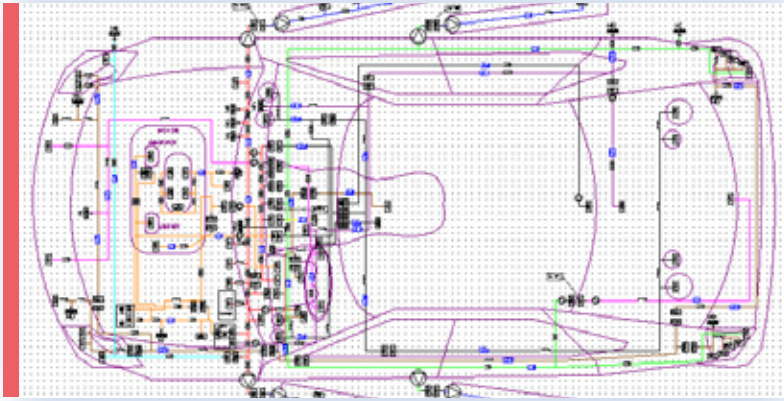

Automotive

› Market Requirements

- Hybrid vehicle technologies
- Shorter development time
- Options management
- Increasingly complex electronic content

› IGE+XAO answers

- Powerful PLM (Product Lifecycle Management) suite
- Automotive specific functions
- High level of integration
- Configuration management (options and variants)

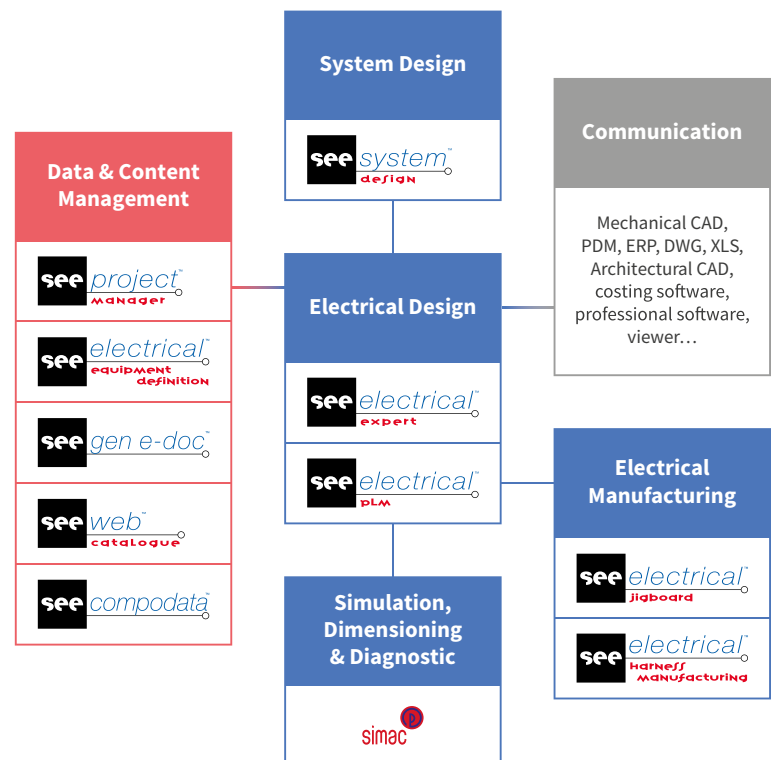

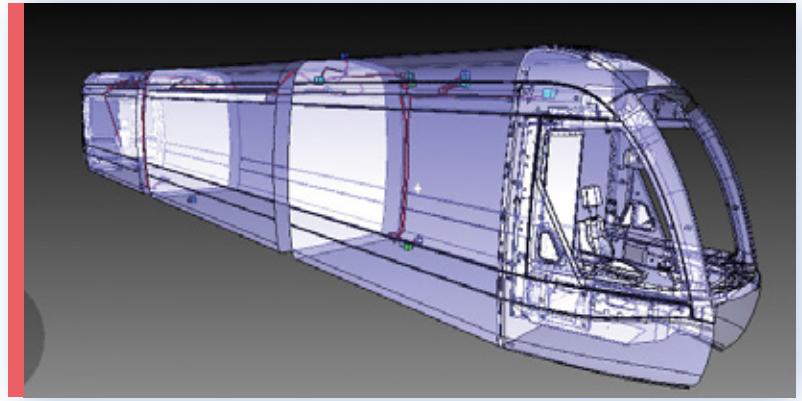
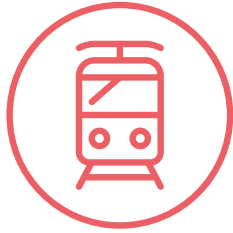

Railway

› Market Requirements

- “Intelligent train”
- Equipment reliability
- Safety
- Eco efficiency
- Additional comfort and services

› IGE+XAO answers

- Powerful PLM (Product Lifecycle Management) suite
- Railway specific functions
- High level of integration
- Traceability
- Configuration management

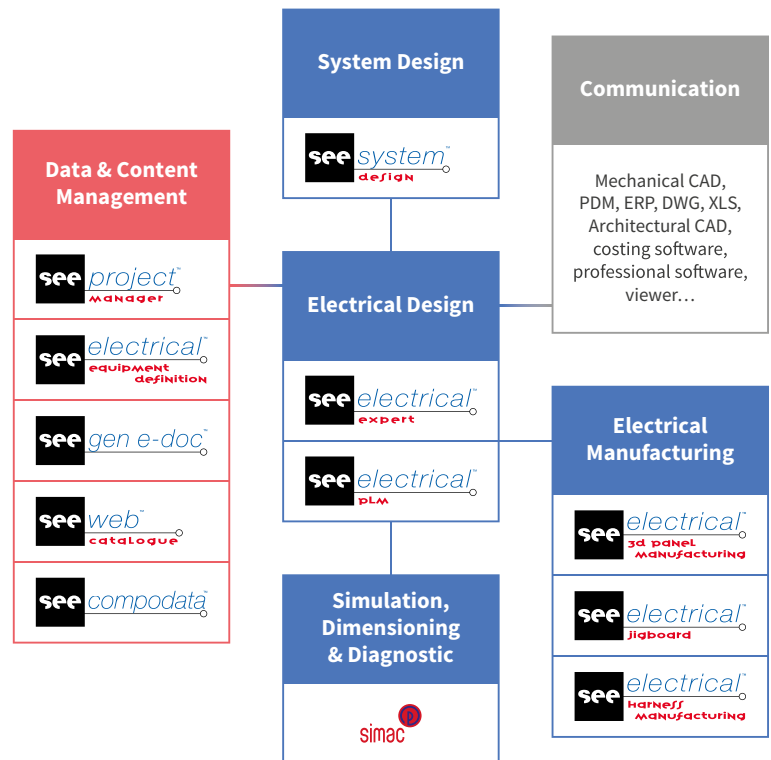

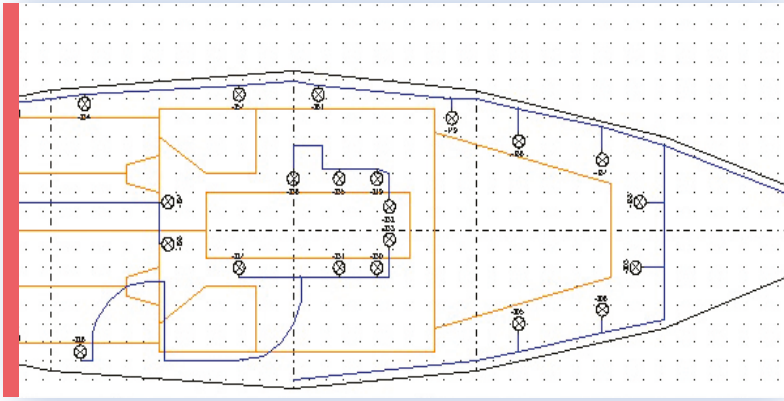

Shipbuilding

› Market Requirements

- “Smart” ship
- Increasing number of equipment
- Operational condition guarantee
- Ship lifelong evolutions
- Cost optimization

› IGE+XAO answers

- Complete Visio-based offer that goes from functional design to schematics and cabling generation
- Communication capabilities (PLM and CAD integration)
- Collaborative design
- Multi function (hydraulics, pneumatics, electrical...)
- Configuration management (options and variants, versioning/maturity)

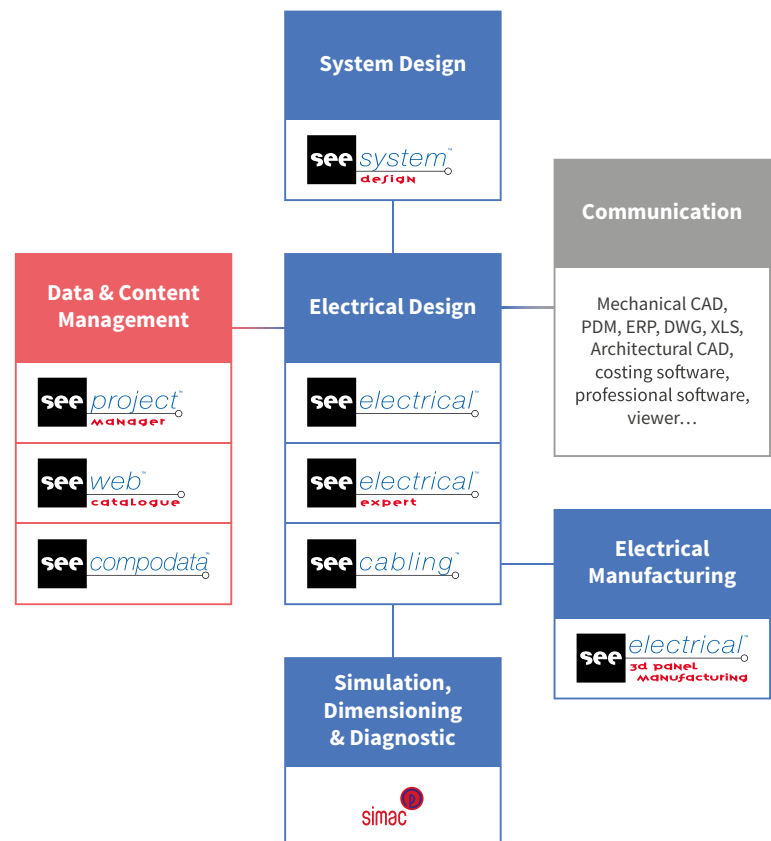



Equipment & Machinery

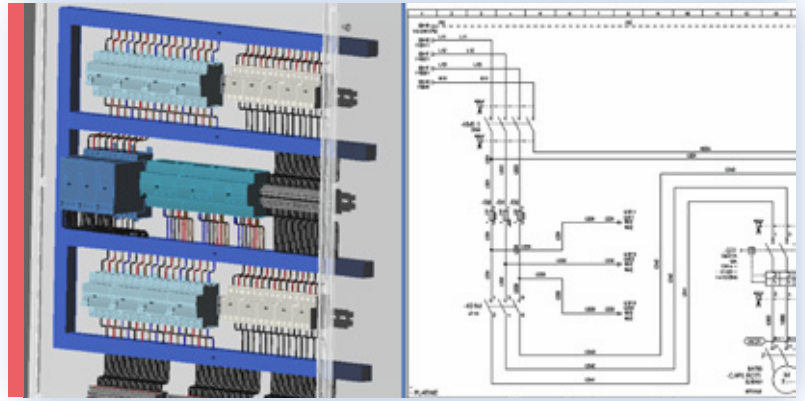

› Market Requirements

- More and more complex equipment
- Customization
- Reliability

› IGE+XAO answers

- Solutions for all company sizes
- One of the most complete product ranges on the market
- Communication capabilities
- Customizable and scalable solutions
- Expertise from large customer base
- Strong partnership with key electrical equipment players
- Wire harnesses expertise
- Automatic schematic generation

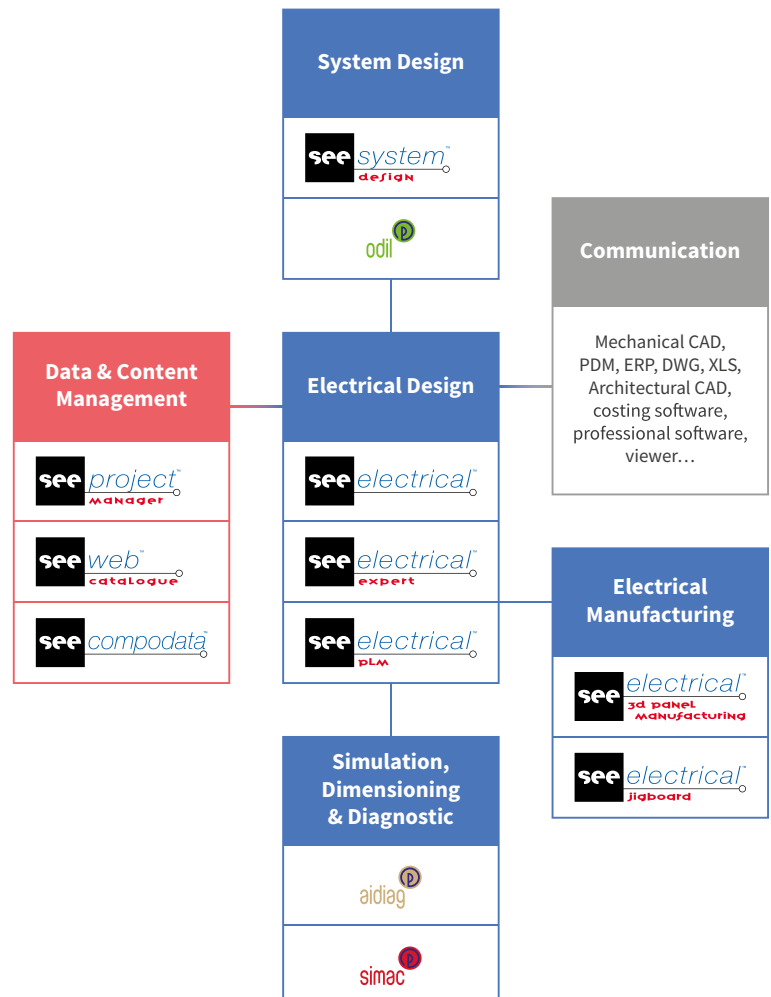

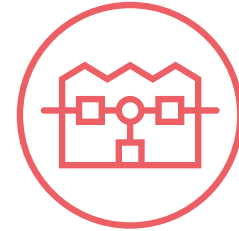
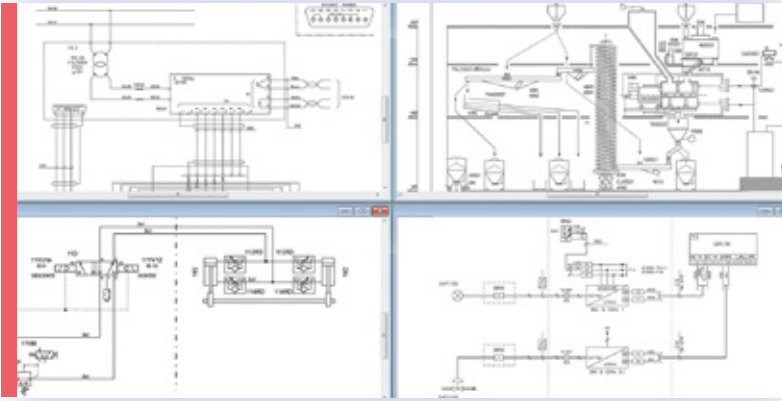

Automation & Plant

› Market Requirements

- Lifetime cost optimization
- Reliability
- Predictive maintenance
- Flexibility

› IGE+XAO answers

- Solutions for all company sizes
- One of the most complete offer on the market
- Communication capabilities
- Best-in-class features
- Complete environment (CEI, IEC, symbols...)
- Customizable and scalable solutions
- "Easy to use" software
- Expertise from large customer base
- Quality verification functions

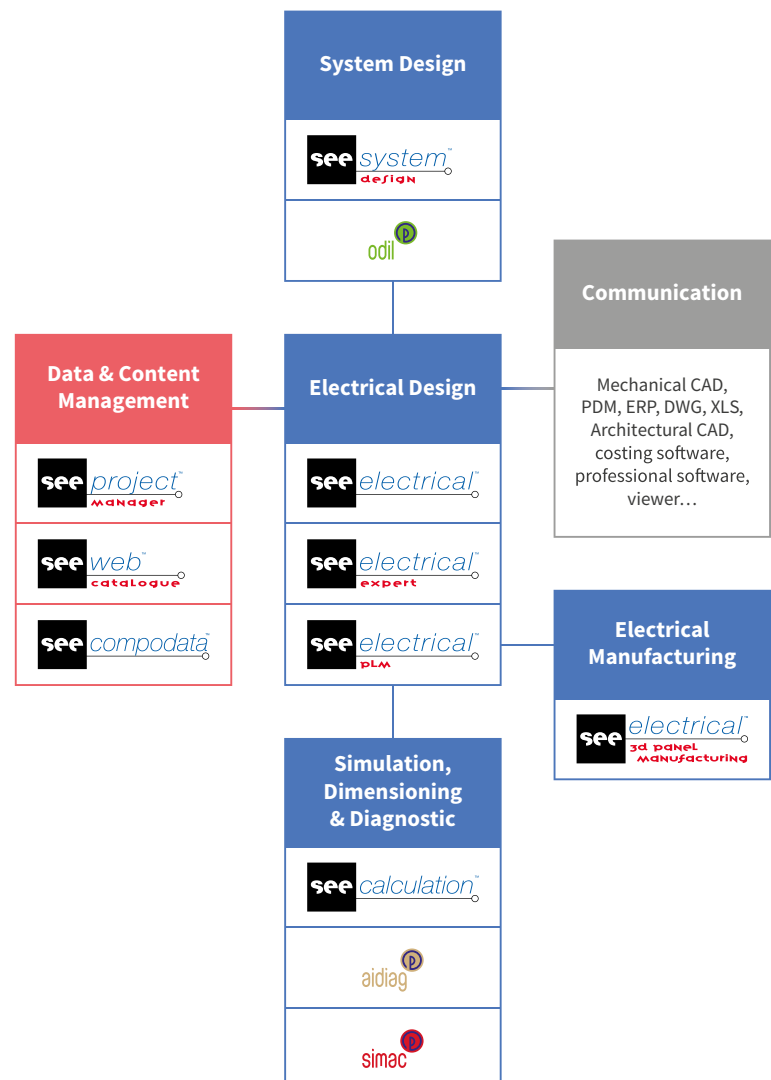

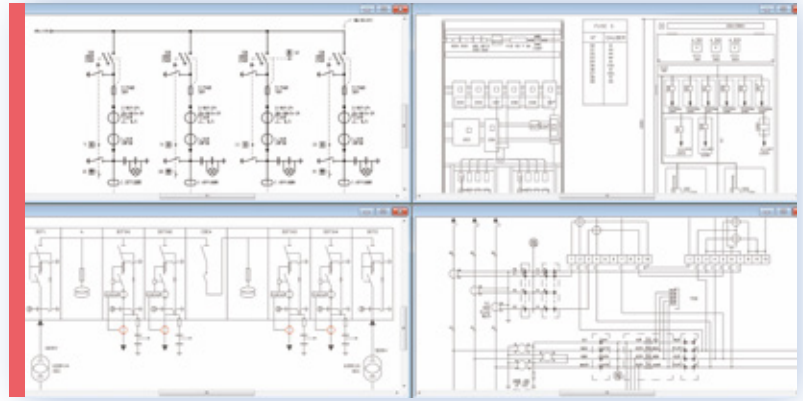

Power Generation & Energy

› Market Requirements

- Safety
- Alternative & sustainable energies
- Smart supply and demand
- Smart grid
- 24/7 operations
- Environmental regulations

› IGE+XAO answers

- Complete offer from a powerful Visio-based offer to “on-the-shelf” easy to use packages
- Communication capabilities
- Collaborative solution
- Customizable and scalable solutions

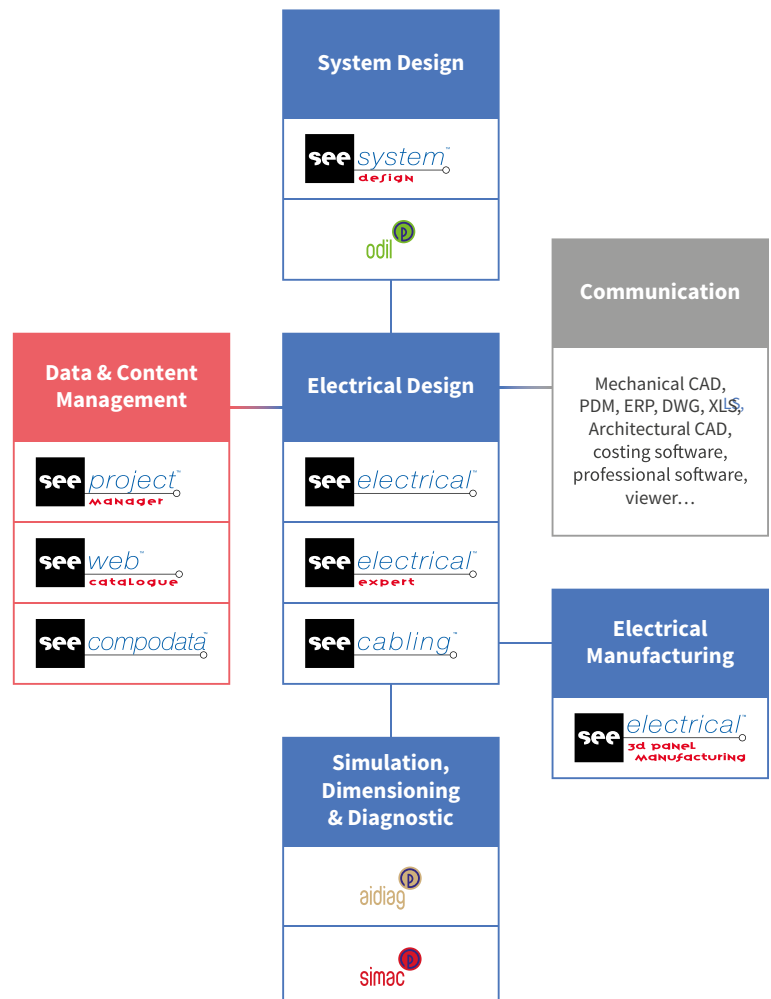

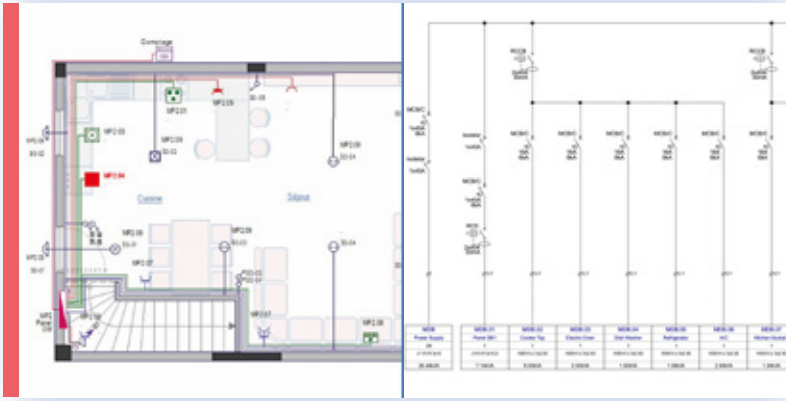

Construction

› Market Requirements

- Smart buildings
- Increasing number of equipment (datacom)
- Importance of standards/regulations

› IGE+XAO answers

- Automatic schematic generation
- “All in one” product
- Easy-to-use calculation package
- Communication capabilities

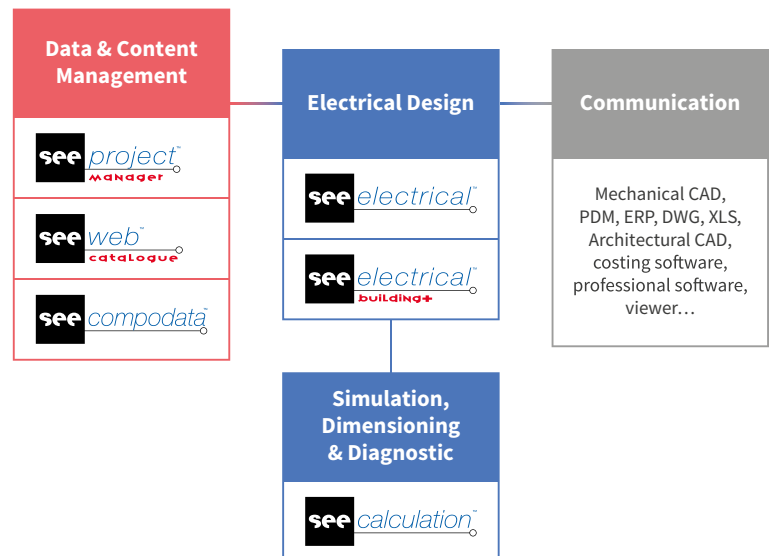

Value-added services

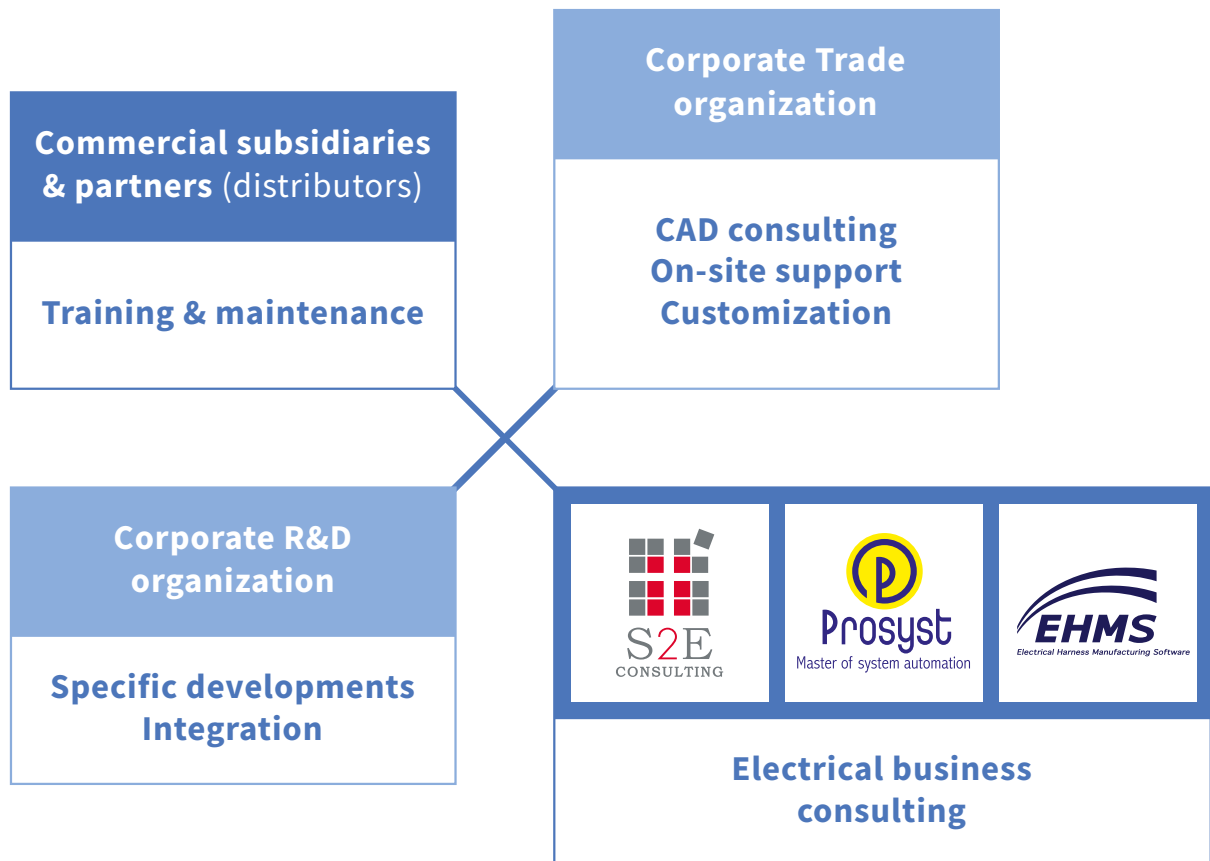

Training sessions adapted to clients' needs and worldwide telephone helpline. Over 70 experts are available to our clients for in more than 12 languages throughout the world.

Dedicated team to customize the software to our clients' needs

The “Assistance+” team supports our clients in implementing and integrating IGE+XAO solutions. Our R&D team also provides specific developments as well as integration services.

Value-added consulting

Created in collaboration with the SOGECLAIR Group, S2E Consulting offers assistance and consulting services dedicated to system engineering and optimization of electrical design processes.

Prosyst also provides consulting services around electrical simulation and diagnostic.

An organization built around our clients

In response to the market fast-moving needs, the IGE+XAO Group has put in place an “extended enterprise” organization.

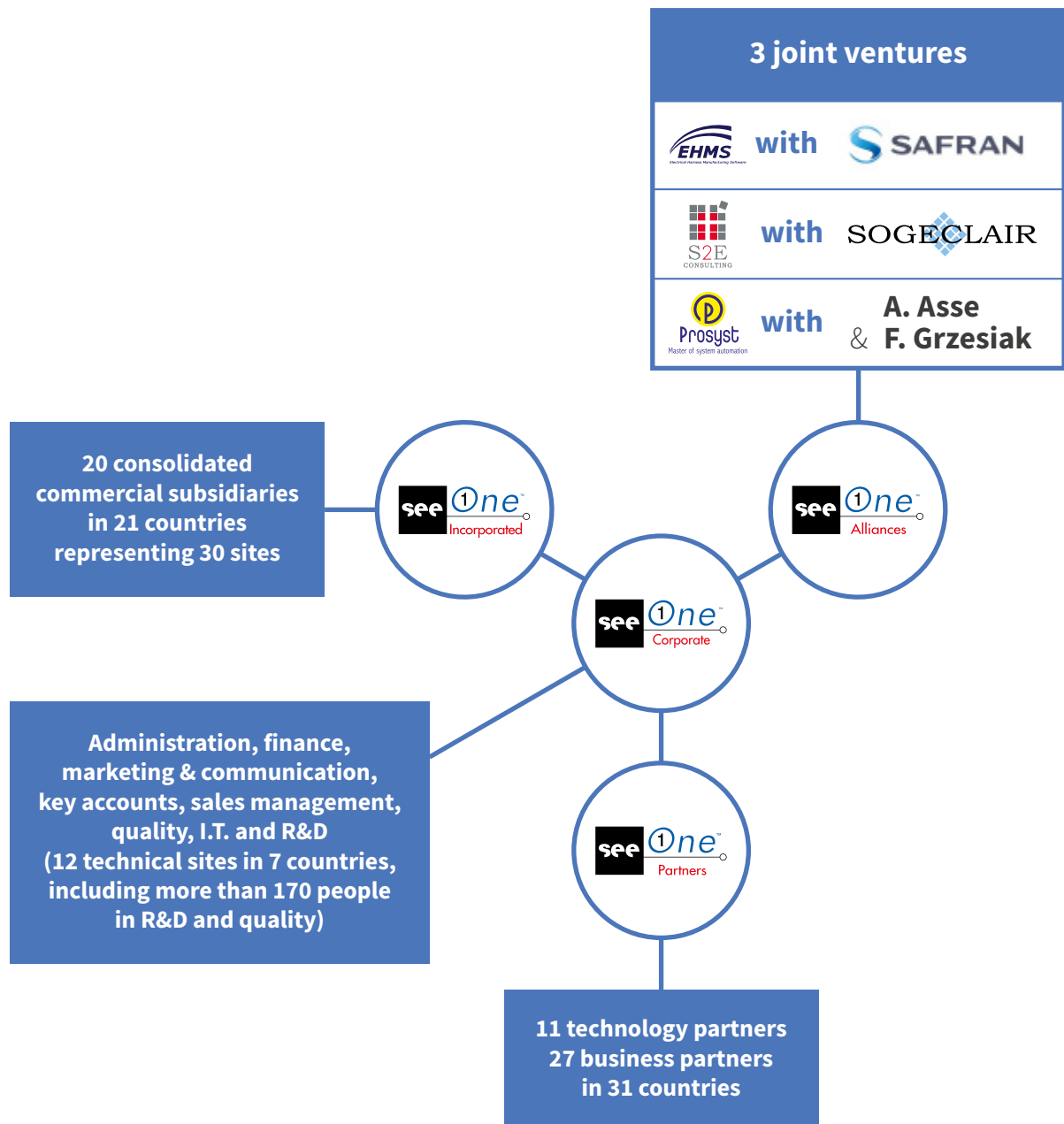

Research and Development

Innovation

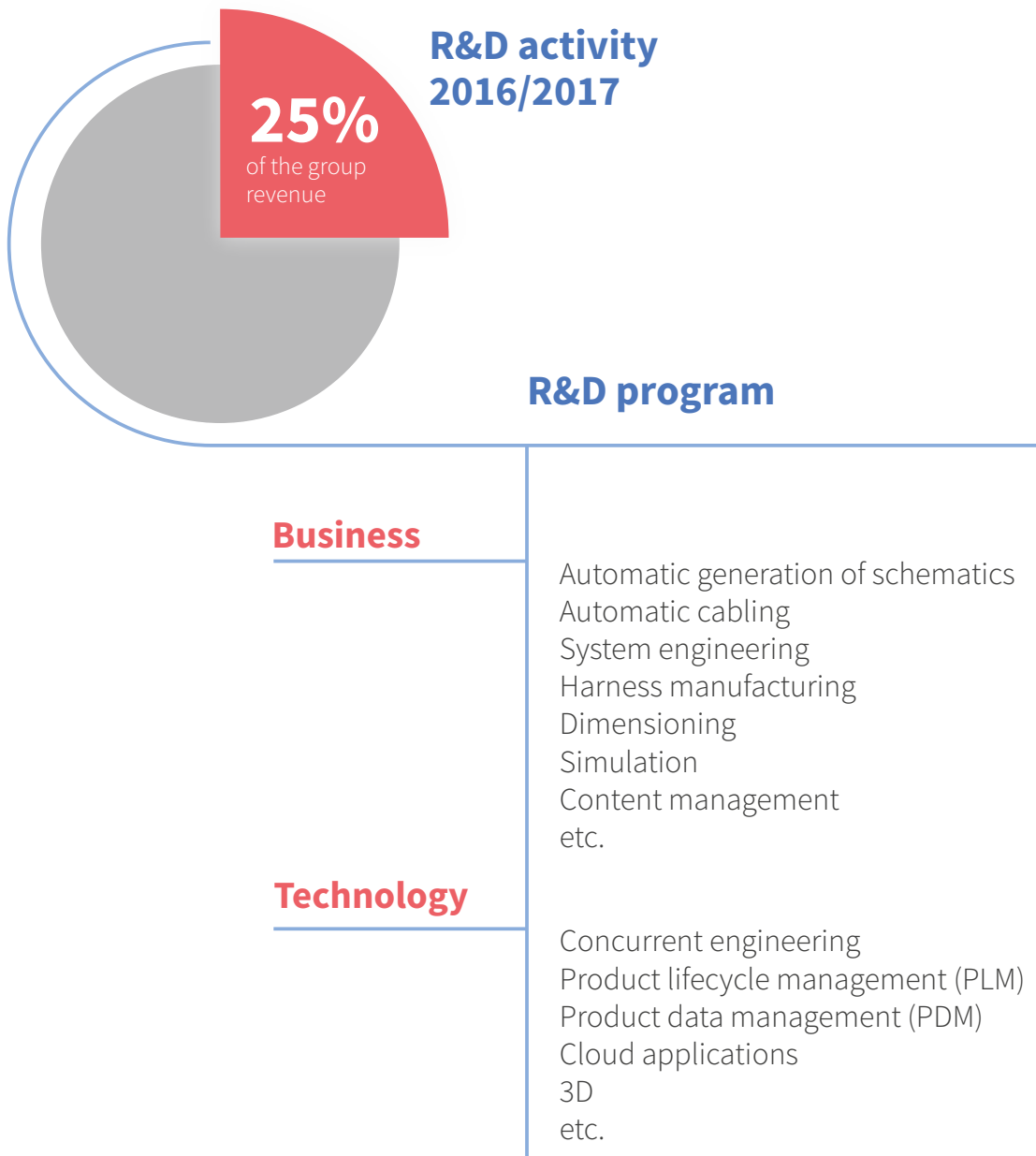

➤ **170 people focused on Electrical CAD and PLM, Design, test and quality**

| Strong values

Strong and shared values are key to the Group success.

- **Openness**
- **Boldness**
- **Dynamism**
- **Professionalism**
- **Consideration for customers and staff**

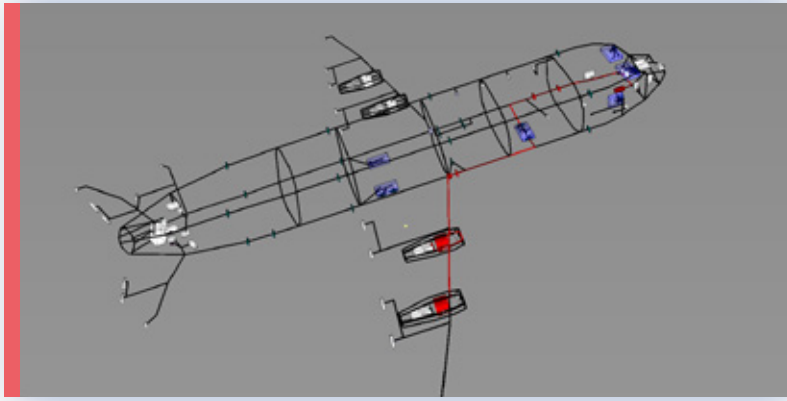

+ 31 years of experience

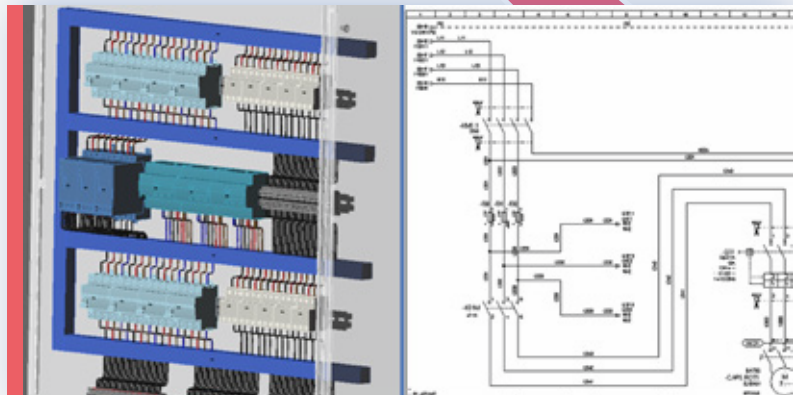

+ 385 employees

+ 33 locations in 22 countries

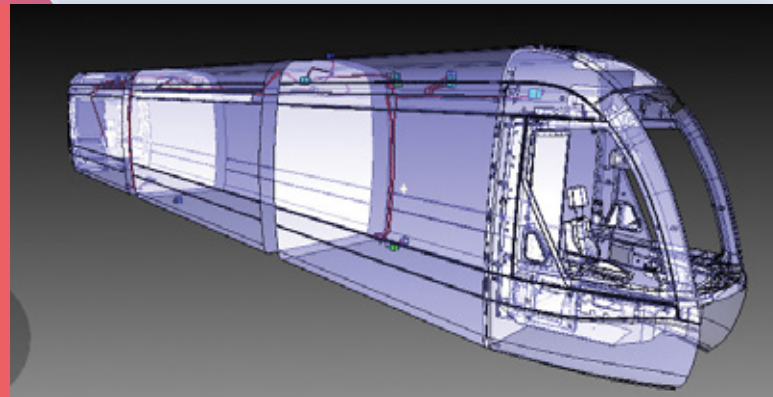
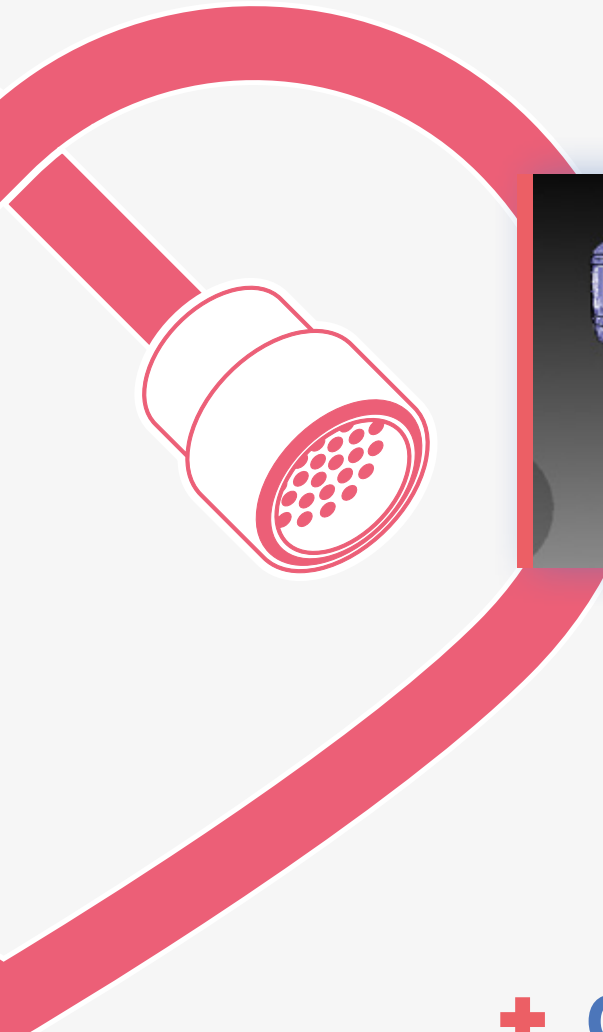

+ Over 88,000 licences sold

LOCATIONS

IGE+XAO Headquarters – France

16 bd Déodat de Séverac
31 770 **Colomiers** CEDEX
CS 90 312 – France
t. +33 (0)5 62 74 36 36

IGE+XAO Belgium

Terhulpsesteenweg 181 bus 21
1170 **Brussel**
t. +32 (0)2 219 09 59

IGE+XAO Bulgaria

205 Al. Stamboliyski Blvd.
1309 **Sofia**
t. +359 2 8101 145

IGE+XAO Brazil

Rua Nabor Antônio Crozariol, 259b
Residencial Estoril
Taubaté, São Paulo
CEP 12092-762
t. +33 05 62 74 36 36

IGE+XAO Canada

7777, Boul. Louis-H. Lafontaine
suite 201 – **Montréal** (Anjou)
Québec H1K 4E4
t. 1-514-353-3445

IGE+XAO China

Room 21N1
Huatai Securities Building
No.90 East ZhongShan Road
Nanjing 210002
t. +86 (0)25 8689 0716

IGE+XAO France

72, av. de la République
92 320 **Châtillon**
t. +33 (0)1 55 48 17 77

3, rue de Lorraine
44240 **La-Chapelle-Sur-Erdre**
t. +33 (0)2 51 89 72 12

Centre Étoile Valentine – Bât. B4
20 Traverse de la Montre
13 011 **Marseille**
t. +33 (0)4 91 44 89 06

106, rue de la Liberté
38 180 **Seyssins**

t. +33 (0)4 76 70 16 42
30 rue des frères Dana
59 300 **Valenciennes**
t. +33 (0)3 27 30 59 59

IGE+XAO Germany

Marie-Bernays-Ring 19a
D-41199 **Mönchengladbach**
t. +49 (0)2166 13 39 10

Im Wöhr 2
D-76437 **Rastatt**
t. +49 (0)7222 77 47 40

IGE+XAO Greece

3 Promitheos str
GR-54627 **Thessaloniki**
t. +30 23 10 24 49 11

IGE+XAO India

No. 26, Benson A Cross Road
Byadarahalli
Benson Town
Bangalore 560046
t. +91 9535235447

IGE+XAO Italy

Via delle Canovine, 46
I-24126 **Bergamo**
t. +39 035 45 96 167

IGE+XAO Morocco

24, rue Ali Abderrazak
Quartier Racine Extension
1er étage
20100 **Casablanca**
t. +212 5 22 23 05 55

IGE+XAO Nordic

t. +45 45 94 21 00
Bistrupvej 22
3460 **Birkerød**
Denmark

Haslegårdsvej 8
8210 **Aarhus V**
Denmark

IGE+XAO Netherlands

Beersdalweg 84 A
6412 PE **Heerlen**
t. +31 (0)45 561 16 36

IGE+XAO Poland

Pl. Na Stawach 3
30-107 **Kraków**
t. +48 12 630 30 30

ul. Strusińska 2
33-100 **Tarnów**

ul. Doktora Józefa Putka 9
34-100 **Wadowice**

IGE+XAO Spain

Parque Empresarial Neisa Sur
Edif. N°7, Av. Andalucia Km 10,5
E-28021 **Madrid**
t. +34 91 797 90 71

IGE+XAO Switzerland

Rue de Flore 5
CH-2502 **Biel/ Bienn**
t. +41 (0) 32-365 93 93

IGE+XAO Tunisia

Pôle technologique El Ghazela
Bloc I2 Rdc A04
Rte de Raoued km 3,5
2088 **Ariana**
t. +216 70 83 45 45

IGE+XAO Turkey

Küçükbakkalköy Mah.
Vedat Günyol Cad.
Flora Residence No:1
Kat:28 D. No:2803
34750 Ataşehir / **İstanbul**
t. +90 (0) 216 988 1600

IGE+XAO UK

Unit 7
Riverside Court
Station Road
Croft
Leicestershire
t. +44 (0)247 679 6426

IGE+XAO USA

2540 King Arthur Blvd.
Suite 209-M
Lewisville, TX 75056
t. +1 (972) 410-3610